



Conservaflash

Version: 3.0
Date: July 2005



features & benefits

Conservaflash™ is a pre-formed PVC flashing system that will change the way you install. Conservaflash™ is an engineered product offering professional results - in a flash!

- **Save at least an hour on each installation.**
- **An engineered solution - each and every time.**
- **No waste - precise amount required.**
- **Comes with the roof - an integrated solution.**
- **Convenient, pre-packed with no environmental risks.**

Three unique features:-

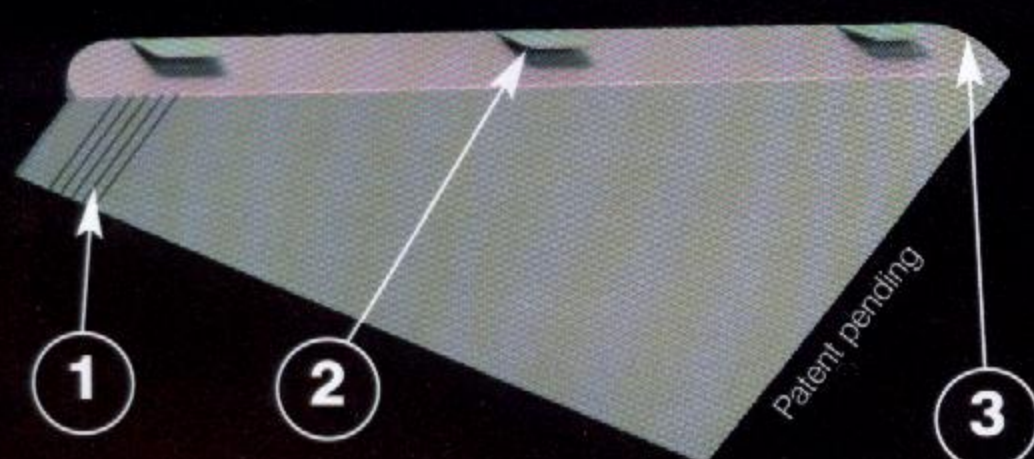

- 1 - Conservaflash™ features "belt and braces" weatherproofing. On the face side of each pre-formed unit are a series of capillary grooves whilst on the reverse, twin weatherbar grooves act as a primary weatherseal and locator for silicone.
- 2 - Integral mechanical retention is with a 93° angle that physically restrains the flashing into the chase acting in tandem with the wedge clips on the top edge and the wedge ribs on the underside. All of these features hold Conservaflash™ in place during back pointing.
- 3 - Profiled corners, radiused to the largest (9") angle grinder, eliminates the need to "over cut" the mortar joint.

specification

Conservaflash™ is manufactured from PVC and comprises :-

- Extruded soaker that is pre-clipped into the starter bar (Victorian system, Uzone has integral soaker)
- Stepped flashings, incorporating weather bars, for 5 different pitch ranges
- Universal horizontal flashing for lean-to's, aprons on duo-pitch roofs and Ultralite 500 PVC.

Conservaflash™ can be specified when a roof is ordered and a pre-configured flashing pack will be delivered with the roof.

Ultraframe Conservaflash™ can be specified when the host wall is of brick construction.

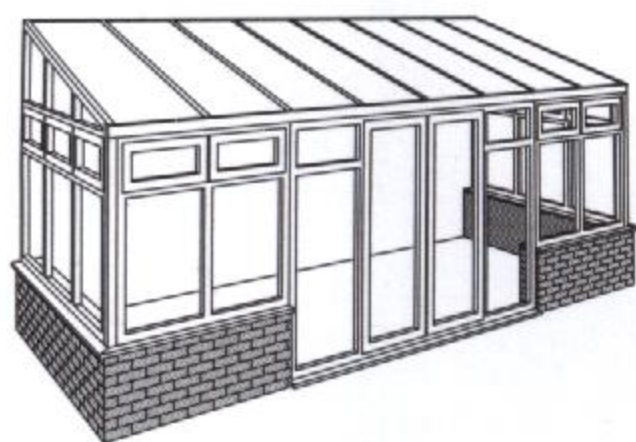

Lean-to conservatory

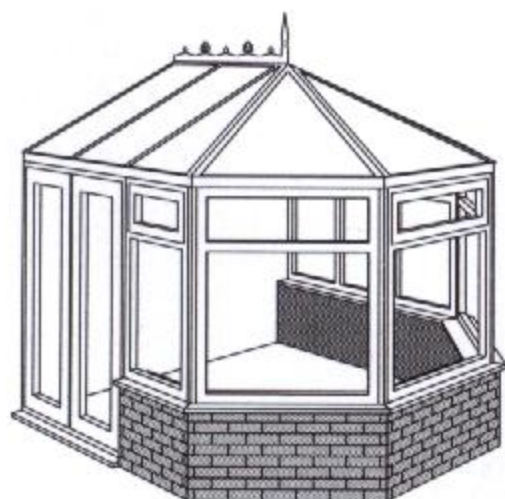

Duo-pitch conservatory

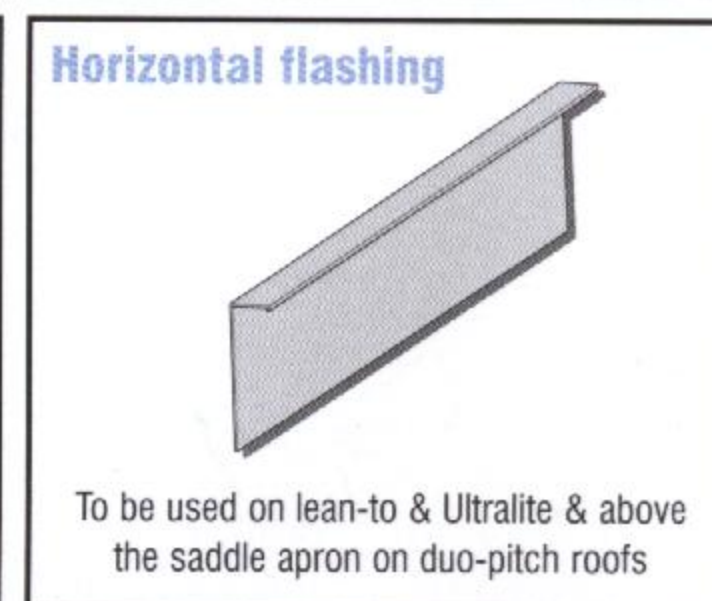
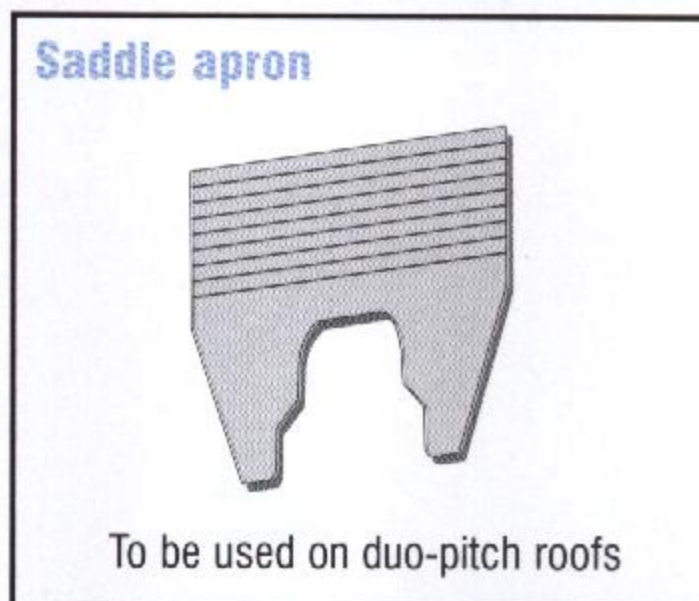
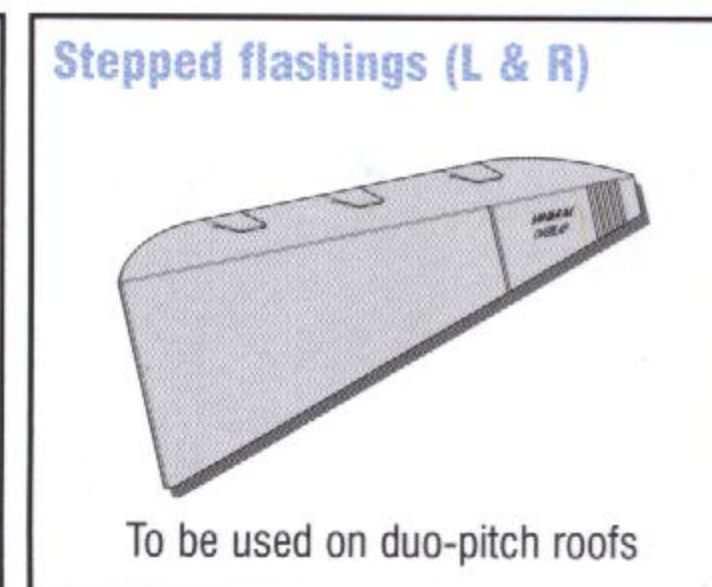
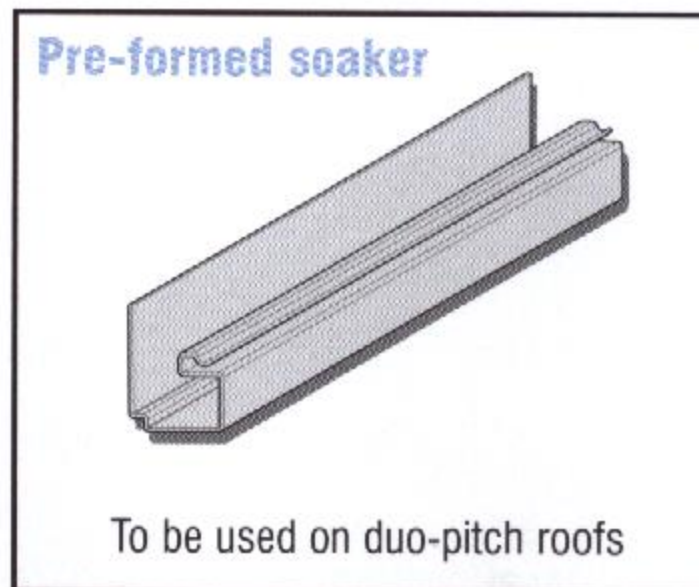

	Pre-formed soaker	Stepped flashing (L&R)	Saddle apron	Horizontal flashing
UZONE	(Integrated into starter bar)	●	(Combined saddle/ flashing trim)	●
VICTORIAN	●	●	●	●
ULTRALITE / LEAN-TO'S				●

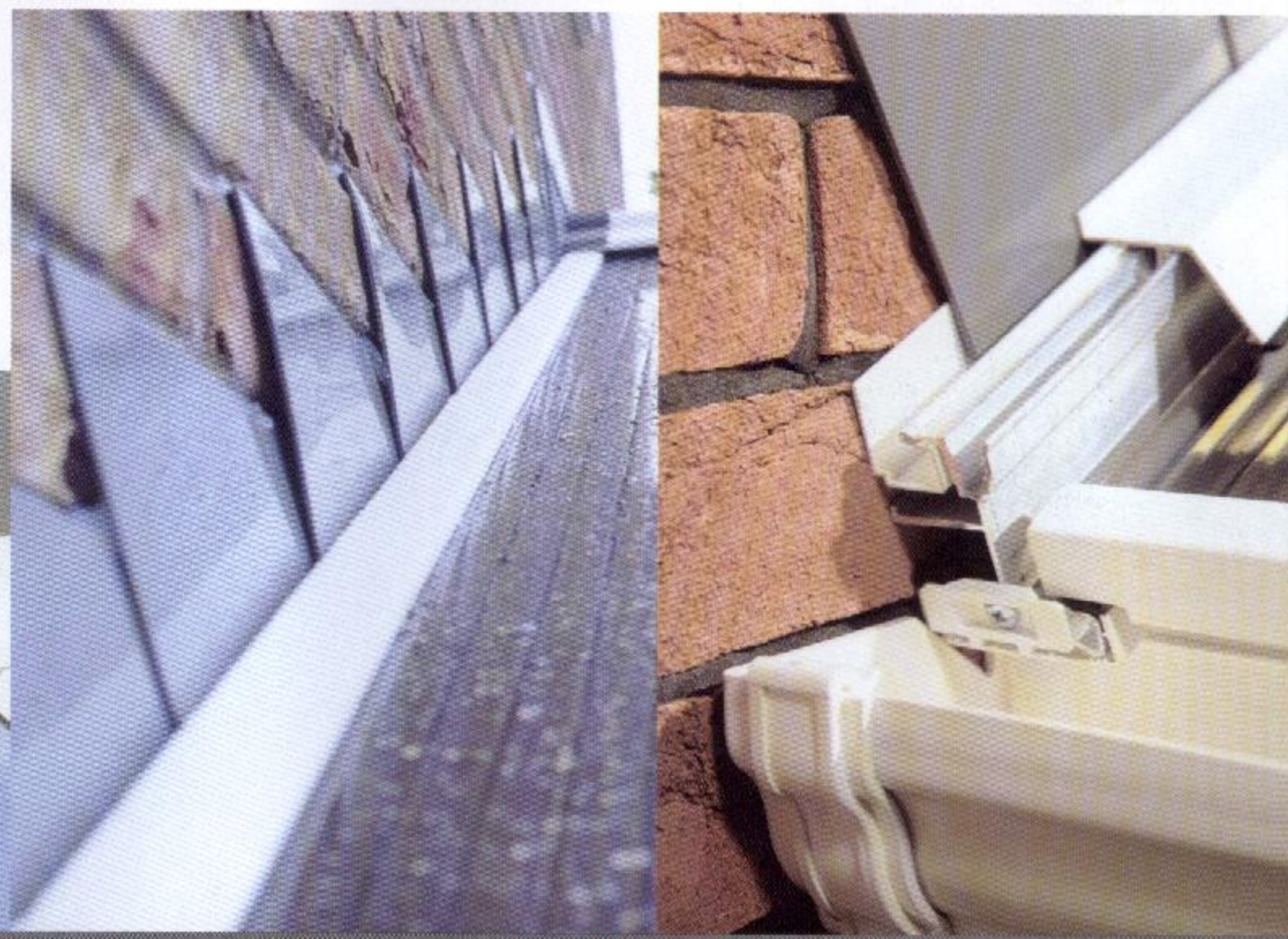

Installation overview



Chase out with grinding wheel



Start installing Conservaflash™ from gutter end towards the ridge



Install pre-formed apron flashing and silicone the joint